

OSSICOLOR
innovative aluminium



Passione per l'alluminio

L'alluminio è un metallo dai molteplici vantaggi: atossico, resistente alla corrosione, leggero e soprattutto riciclabile. Oltre la metà dell'alluminio presente nel mondo, deriva da un processo di riciclo e questo si traduce in un vantaggio per la natura e per la comunità, consentendo di risparmiare oltre il 90% dell'energia necessaria per la sua produzione.

Ossicolor fabbrica da oltre 50 anni prodotti in alluminio, attraverso un ciclo produttivo che pone il rispetto dell'ambiente al centro del proprio sviluppo e tenendo sempre fede alla propria filosofia delle origini: passione per il territorio Trentino e voglia di stupire innovando.

In collaborazione con lo studio di design **Ultramateria**, abbiamo realizzato ALUFRAME, ALUBOX, N.3 e 4 STAGIONI.

Attraverso questi prodotti desideriamo contribuire a un futuro sempre più sostenibile per il bene delle generazioni presenti e future.

Se anche tu condividi il medesimo obiettivo, contattaci: ti aiuteremo a realizzare i tuoi progetti.



A passion for Aluminium

Aluminium is a metal of multiple advantages: non-toxic, corrosion-resistant, lightweight and, above all, recyclable. More than half of the aluminium currently in use worldwide comes from recycling processes, representing a significant benefit for both the environment and the community, as it allows savings of over 90% of the energy required for its production.

For over 50 years, Ossicolor has been manufacturing aluminium products through a production cycle that places respect for the environment at the core of its development, always remaining true to its founding philosophy: a passion for the Trentino region and a constant drive to amaze through innovation.

*In collaboration with the design studio **Ultramateria**, we have developed ALUFRAME, ALUBOX, N.3 e 4 STAGIONI.*

With these products, we aim to contribute to an increasingly sustainable future, for the benefit of present and future generations.

If you share the same goal, contact us: we will help you bring your projects to life.



ALUBOX

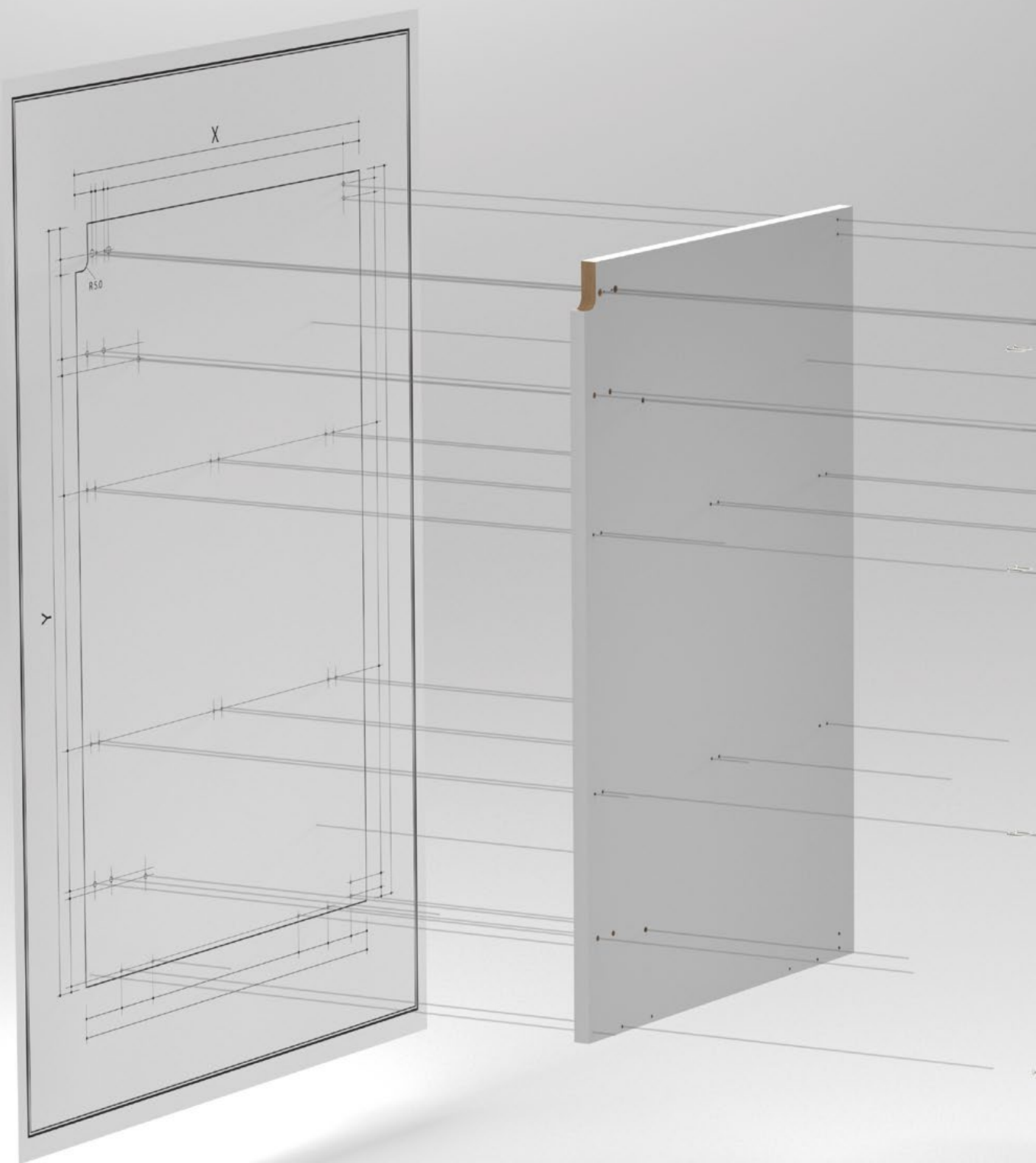

ALUBOX Trasposizione in alluminio del classico sistema costruttivo a moduli. La particolare lavorazione meccanica d'incisione e piega della lamiera, abbinata all'utilizzo di elementi di unione in estruso, consente di ottenere una struttura robusta e dall'estetica minimalista. I moduli in alluminio possono essere utilizzati per sostituire totalmente o solo in parte quelli realizzati in legno, proteggendo le sole aree esposte all'umidità.







Completamente in alluminio
Fully aluminium



Resistente all'acqua
Waterproof

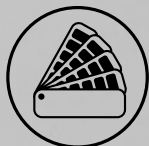

Colori personalizzabili
Available in custom finishes



Pensile
Wall cabinet



Base sottolavello
Sink base cabinet



Base per ante
Base cabinet for doors



Struttura per appoggio
Furniture leg frame

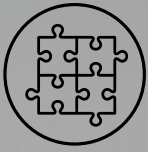

Modulare
Modular



Fatto su misura
Tailor made



Riciclabile 100%
100% recyclable



Base per cassetti
Drawer base cabinet



Colonna frigo
Fridge cabinet

ALUFRAME



Completamente in alluminio
Fully aluminium

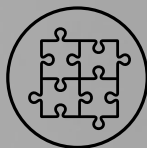

Modulare
Modular



Resistente all'acqua
Waterproof



Fatto su misura
Tailor made



Colori personalizzabili
Available in custom finishes



Riciclabile 100%
100% recyclable

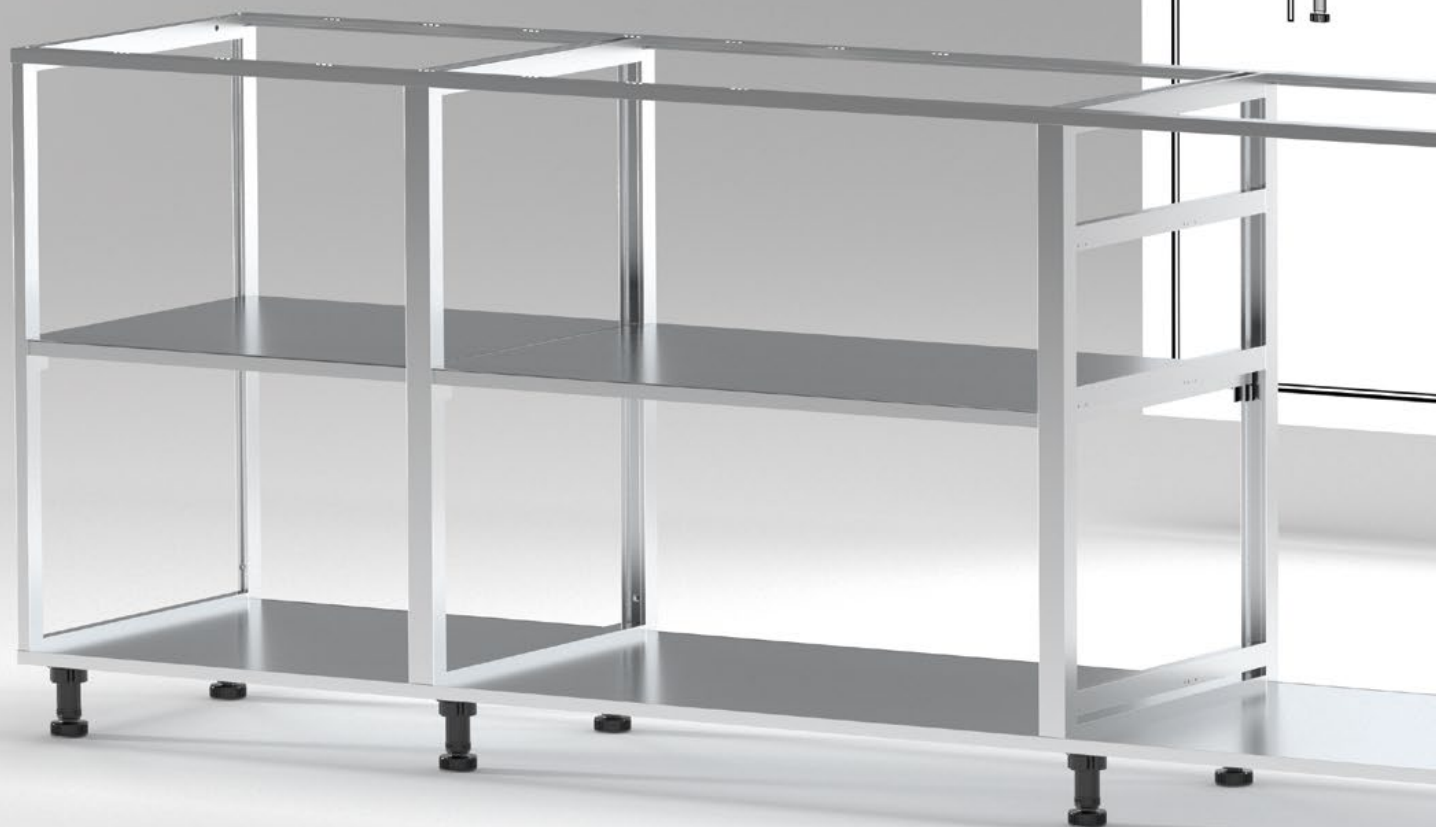
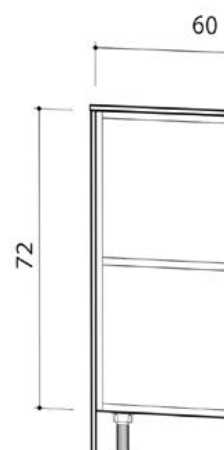

ALUFRAME Struttura per cucina in alluminio a spalla passante.

Si caratterizza per la ricerca di un equilibrio estetico ottimale fra spazi aperti e vani chiusi.

Il rapido posizionamento delle spalle premontate, consente di trasportare la struttura disassemblata per comporla nel luogo di installazione.



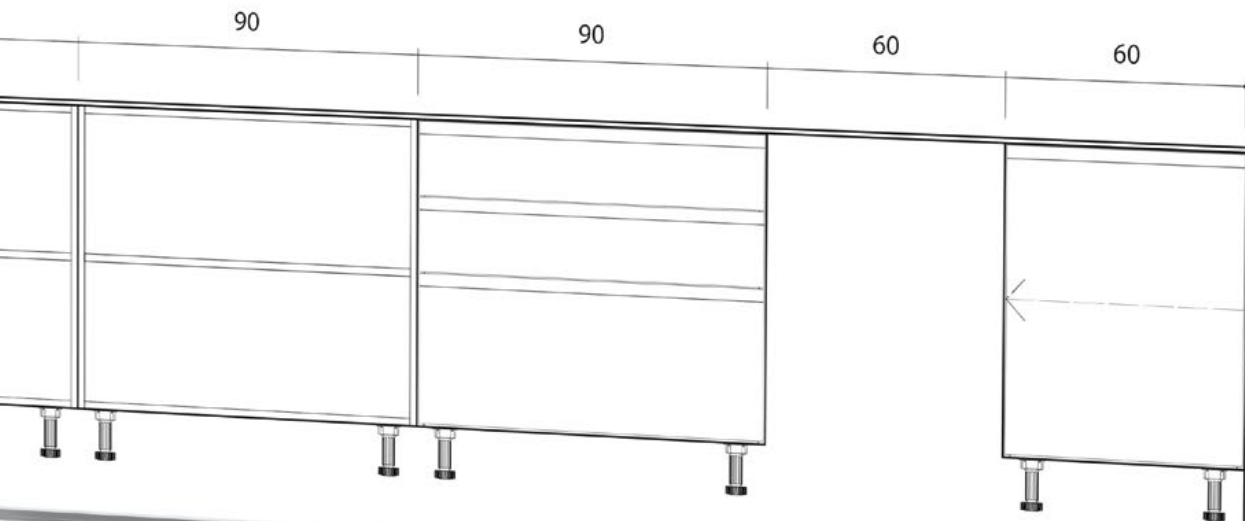

ALUFRAME An aluminium kitchen structure with full-height side panels. It is characterised by the pursuit of an optimal aesthetic balance between open spaces and closed compartments. The quick positioning of the pre-assembled side panels allows the structure to be transported disassembled and assembled directly at the desired site.

ALUFRAME Può essere personalizzata con finiture anodizzate e verniciate e finita con rivestimenti di ogni tipo, come marmo, piani nobilitati e legni masselli negli spessori convenzionali.

La struttura si presta per realizzazioni di penisole e isole con ingombri standard e fuori standard, l'utilizzo di vani a vista con spalle passanti ne conferisce leggerezza e praticità.



ALUFRAME Can be customised with anodised and painted finishes and completed with all types of claddings, such as marble, melamine panels and solid wood in standard thicknesses.

The structure is suitable for the creation of peninsulas and islands with both standard and non-standard dimensions; the use of open compartments with full-height side panels gives the system a sense of lightness and practicality.





Telaio singolo
End frame

N.3

N.3 Struttura iconica per cucina in alluminio, è dotata di cassetti estraibili e può accogliere un'ampia gamma di elettrodomestici e sistemi di cottura.

N.3 *Iconic kitchen structure, equipped with side drawers. It can fit a wide variety of appliances and cooking ranges.*

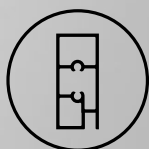

Completamente in alluminio
Fully aluminium



Fatto su misura
Tailor made



Resistente all'acqua
Waterproof



Riciclabile 100%
100% recyclable



Colori personalizzabili
Available in custom finishes

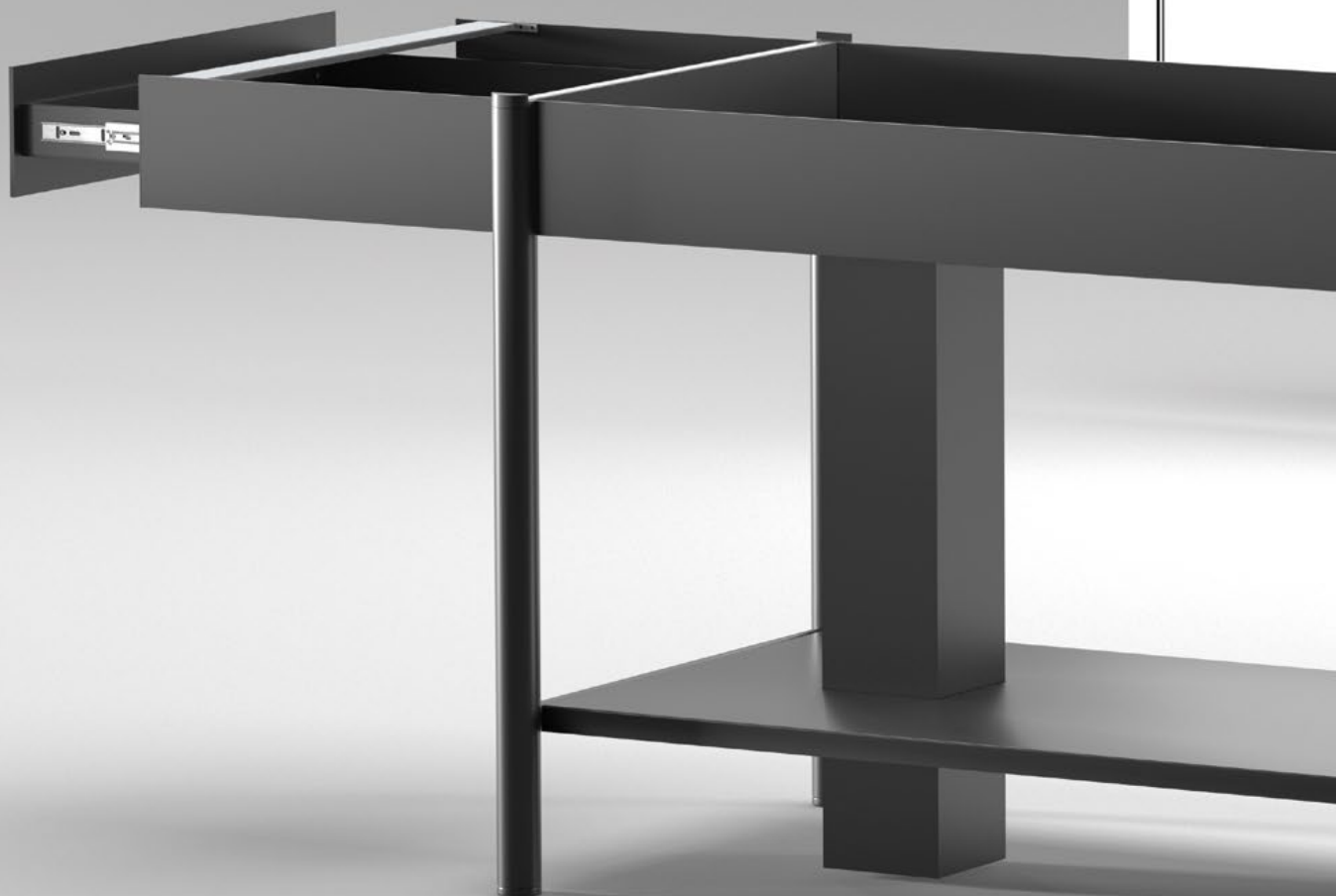



240

70

85





N.3

N.3 Nella sua versione compatta, si trasforma in un carrello dalle grandi ruote che ne consentono il libero posizionamento sia all'interno che all'esterno, per uso cottura o per la preparazione di drink e cocktail.

N.3 *In its compact version, transforms into a cart with large wheels, allowing it to be easily positioned both indoors and outdoors, for cooking use or for preparing drinks and cocktails.*



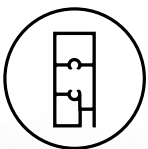
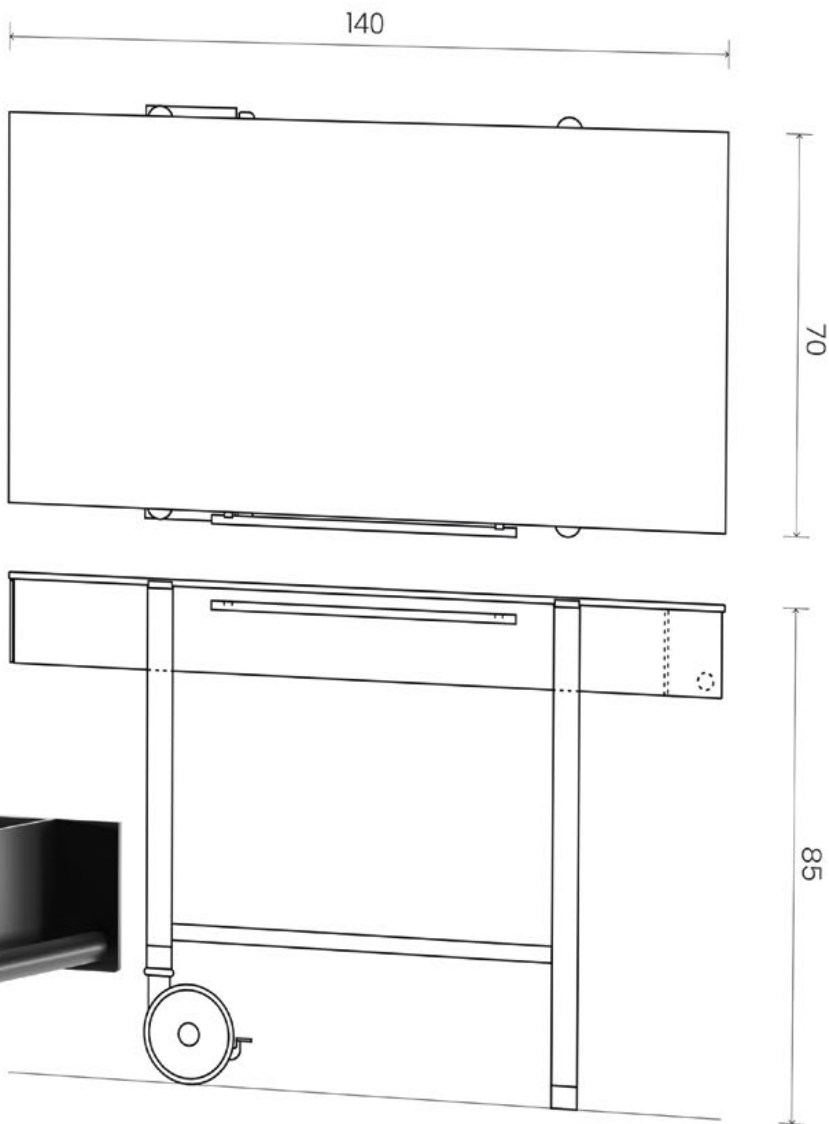

Completamente in alluminio
Fully aluminium

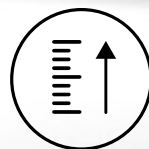

Fatto su misura
Tailor made



Resistente all'acqua
Waterproof



Riciclabile 100%
100% recyclable



Colori personalizzabili
Available in custom finishes





Struttura per cucina 4 Stagioni



Inquadra il QR code.
Scan the QR code.



Completamente in alluminio
Fully aluminium



Resistente all'acqua
Waterproof



Riciclabile 100%
100% recyclable



Colori personalizzabili
Available in custom finishes



Struttura cucina da esterno nero spazzolato.
Brushed black outdoor kitchen structure.



CODICE / CODE	DESCRIZIONE / DESCRIPTION	FINITURE DISPONIBILI / AVAILABLE FINISHES	DIMENSIONI / DIMENSIONS	UM
N.4.1800ARSC35	Struttura cucina da esterno nero spazzolato Brushed black outdoor kitchen structure	ARS-C35	1800x900x764	Kit*

* Il kit è completo come da immagine. Pianali non inclusi. / * The kit is provided as shown in the picture. Shelves not included.

Carrello 4 Stagioni



Inquadra il QR code.
Scan the QR code.





Carrello di servizio per cucine in alluminio nero spazzolato.
Brushed black aluminum service cart for kitchens.



RIF / REF	CODICE / CODE	DESCRIZIONE / DESCRIPTION	FINITURE DISPONIBILI / AVAILABLE FINISHES	DIMENSIONI / DIMENSIONS	UM
1	CARRELLO.N4.550C35	Carrello di servizio per cucine in alluminio nero spazzolato Brushed black aluminum service cart for kitchens	ARS-C35	900x550x550	Kit*
2	CARRELLO.N4.800C35	Carrello di servizio per cucine in alluminio nero spazzolato Brushed black aluminum service cart for kitchens	ARS-C35	900x800x550	Kit*

* Il kit include la struttura in alluminio, 4 ruote e la ferramenta necessaria. Piani non inclusi.

* The kit includes the aluminum frame, 4 wheels, and the necessary hardware. The shelves are not included.

OSSICOLOR

innovative aluminium

Ossicolor Srl

Via Fontanele, 126 - 38010 Spormaggiore (TN) Italy

Tel. +39 0461 653127 - Fax +39 0461 653546

info@ossicolor.it - sales@ossicolor.it

www.ossicolor.it

